

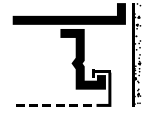

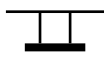

SAS205



A concealed, hook-on suspended metal ceiling system specifically for corridor applications.

SYSTEM GROUP	GRID
	
Suspended Ceiling	Concealed Grid SAS J-Bar suspension

TILE	
	
Hook-on	Square edge

ACOUSTICS	
0.4 - 1.0	15-41dB
NRC	Dnfw*

ACCESS	SYSTEM WEIGHT	LIFE EXPECTANCY
	1.8lbs/ft² Approx.	25yr
Full – Lift and swing down	Based on 4' x 1' tiles 1 3/8" deep*	In excess of

*Note SAS products are tested in accordance with UK standard Dnfw this means CAC will be 2-2.5dB greater. For more information, please see page 19

SAS PLUS

HAVE A QUESTION?

Configurable with other products. Call us.
Contact us on enquiries@sasint.us

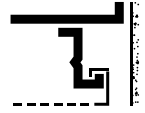

SAS205 is a SAS200 variant, designed specifically for corridor applications. The suspended ceiling system is supported at its perimeters, up to a maximum of 10' widths.

Areas requiring frequent access for maintenance, such as hospitals, residential-blocks and hotels are ideal applications. SAS205 is also commonly specified for commercial offices to blend seamlessly with other SAS suspended ceiling systems.

Module Sizes

There are no standard tile sizes for SAS205. Tiles can be up to 10' in length and no less than 1' wide. Bespoke module sizes and shapes are available on request.

Access

Swing down and hang. Tiles can pivot on one edge to hang in place, offering full void access while keeping tiles safe from harm. This access method is subject to corridor height and width.

Finishes

SAS205 is available in all standard SAS finishes, please refer to page 110. Bespoke finishes are available on request.

Perforations

SAS205 can be manufactured with any standard SAS perforation. For our full range of perforations, please refer to page 84. Bespoke perforations are also an option.

Acoustic Materials

Acoustic mineral wool pad with black tissue face, foil back and sides. Other acoustic materials are available, please refer to page 17.

Service Integration

Tiles can be formed with apertures during manufacturing and post painted for integration with lights and other services.

Please note Loads in excess of 5.5lbs require independent suspension.

Technical Support

Please contact our technical team for all questions relating to access, security, bespoke features, acoustics, service integration or load support.

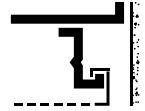

Perspective Drawing

- 1 Closure Angle Support
- 2 J-Bar
- 3 SAS205 Tile

*Lightweight installations only, see page 248 for full details.

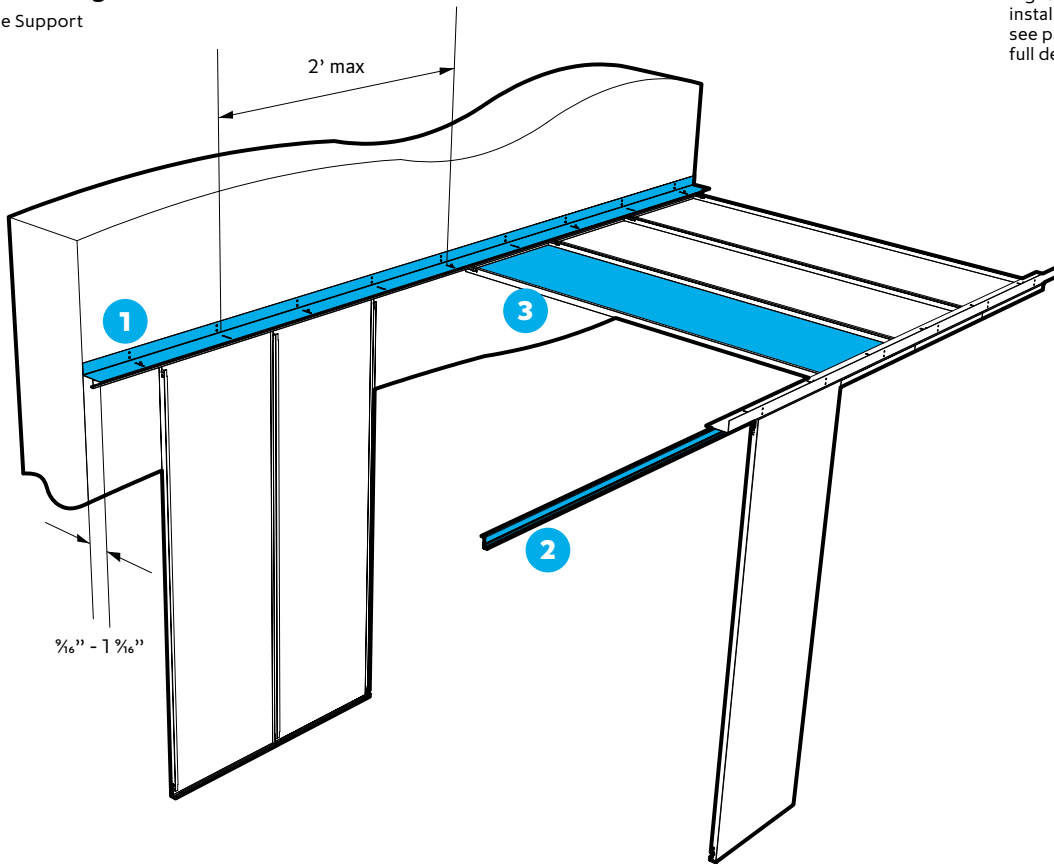

Section drawing

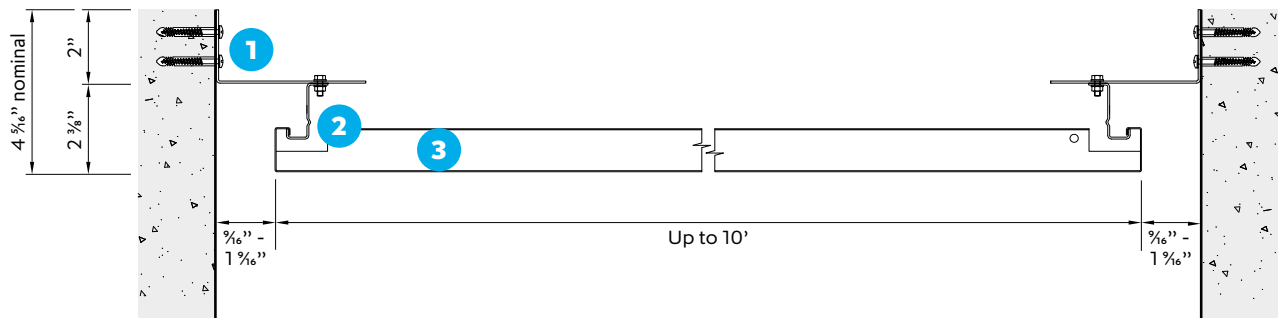

Swing Down Tile

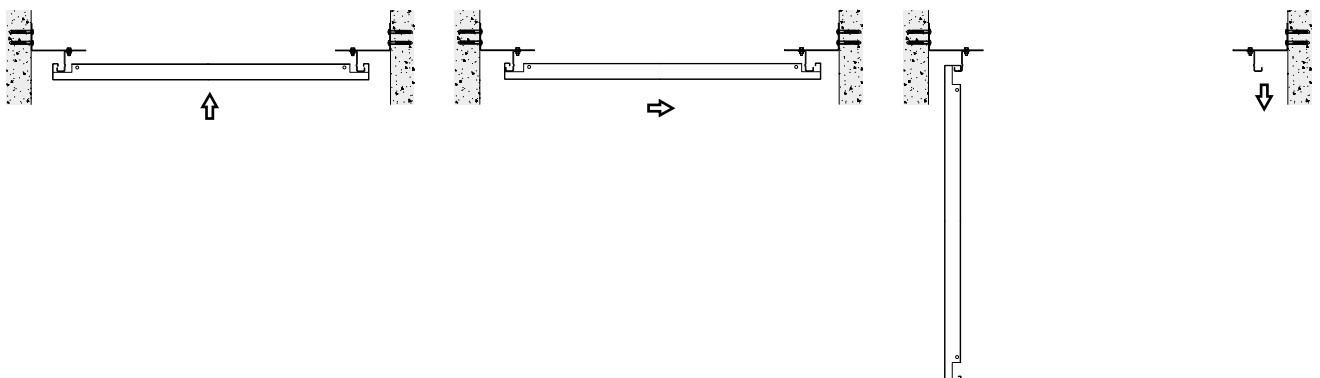

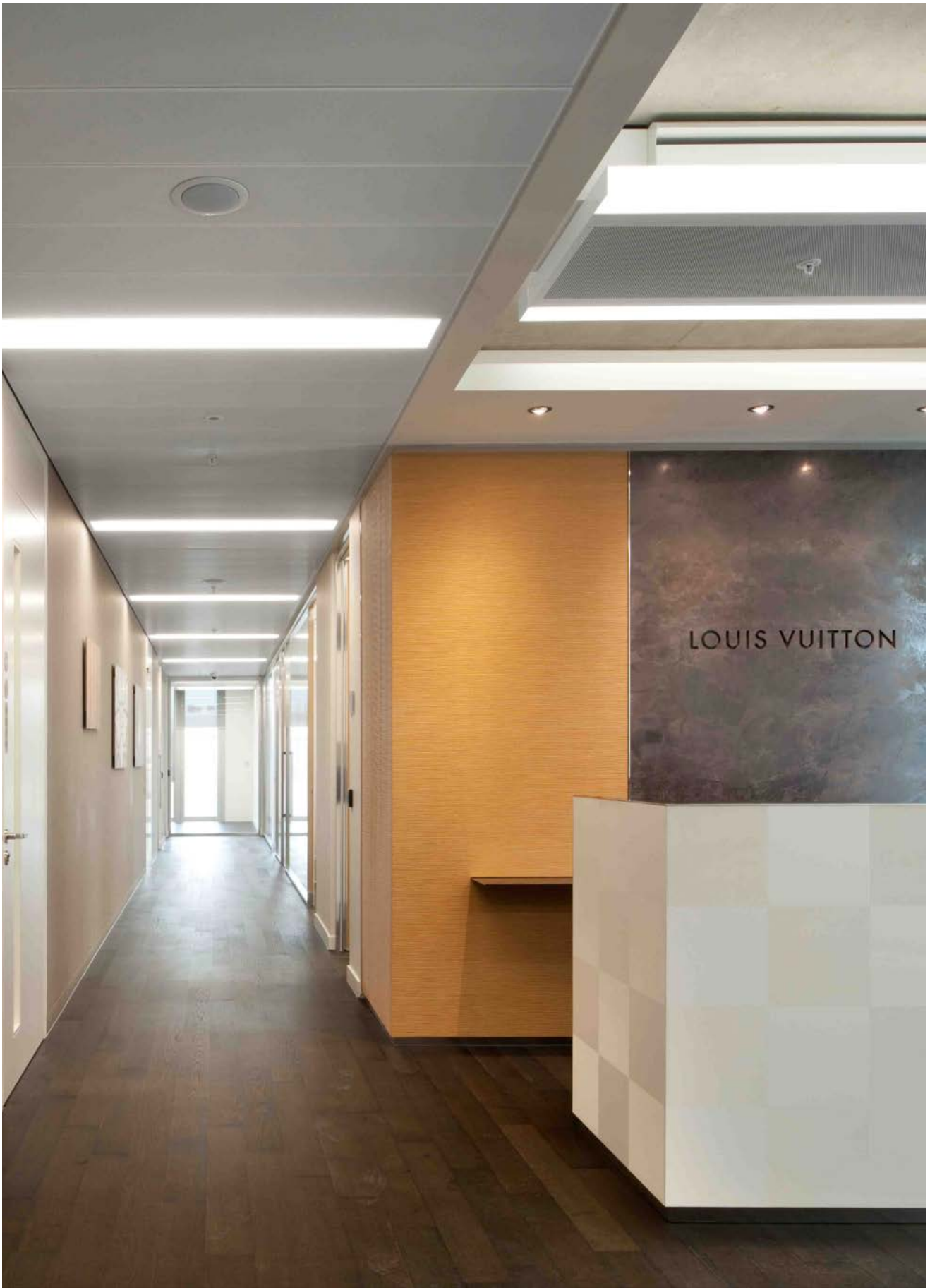

SAS205

Louis Vuitton

Location
London, UK
Architect
**David Chipperfield
Architects**

Contractor
**BAM Construct UK
Ltd**
Purpose
Commercial